

# reflecta®

- Designed to reflect high quality images
  - Designed for simple installation and use

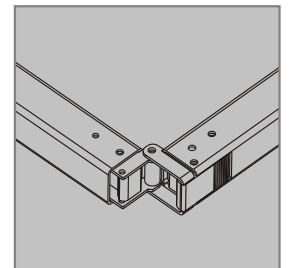
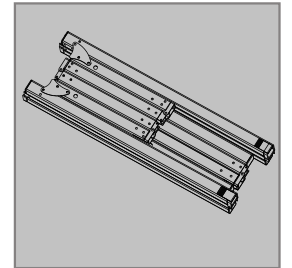
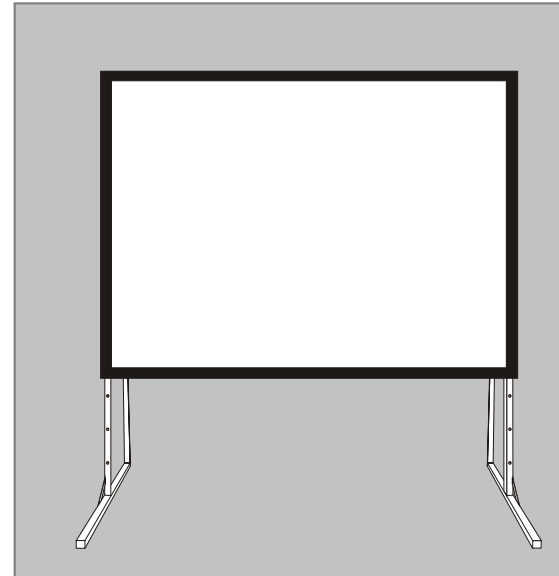

Installation Guide for

## Reflecta Quickset

- Easy to operate and reflects vivid and colorful images.
- Applicable for education venues, meeting rooms, control rooms, boardrooms, training facilities and home theatres
- Specially suited for specific use projectors.

Thank you for purchasing a Reflecta projection screen.

Before use, please read instructions carefully. After installation, store instructions for future reference.

## Thank you for choosing Reflecta

Reflecta screens will reflect the most realistic images and can be used with a wide range of applications. The design is practical yet up to date, a simple choice for any professional or home theatre enthusiast.

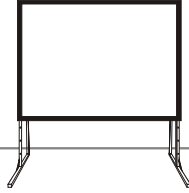

## Product Safety

To ensure your safety, please read "Product Manual and Warnings"

- Please read the following as any damage to the screen surface will affect the quality of the picture:
  1. Avoid contact or touching the screen surface as it may cause scratches or tears.
  2. Do not write or draw on the surface
  3. Clean the screen with a soft cloth and lukewarm water. Do not use any detergent or cleaning products.
- To avoid injury, two people are necessary for both assembly and storage.
- Please use in a location shielded from the elements, especially wind. A strong wind may cause the screen to fall. All pieces of the frame and stand must be used together. The screen can be used separately.
- To prevent unnecessary damage, the operating and maintenance of the screen should be done by adults.
- Please fold up screen and return all parts into the case after every use.

## Product Features

- **Special Design**  
The foldable aluminum structure is light, convenient, easy to carry and store.
- **Smooth Surface**  
When the large sized screen is placed on the frame, it is secured in all 4 corners to keep the screen taut at all times.
- **Convenient and Versatile**  
The packaging is easy and the product is versatile. No tools are needed, and all pieces come with their own turn knobs. Set up only takes 3 minutes. Everything is protected in a carrying case made with LLDPE.
- **Wrinkle-Free**  
The front projection screens use American made matte white material and have a smooth surface, hold their shape and have high elasticity. Rear projection screens also use American materials that have a high level of transparency, allowing more time for the image to pass. The extra soft material allows it to be folded for storage.
- **Location**  
It is suited for various venues such as exhibitions, concerts, banquets, conferences, and etc.

## Warnings

 Ignoring the safety warnings may lead to injuries and/or damaging the product.

 Store back into transporting case after use

 Avoid conditions such as wind and rain when used outside

Do not take apart and replace with unknown parts. If there are any problems, please contact your local dealer. Product specifications are subject to change.

## Description

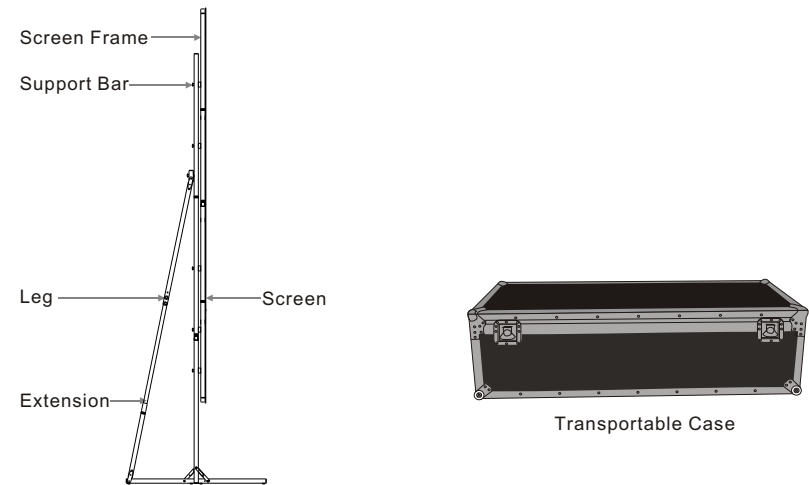

## Accessories

■ Screen Frame (1pc)

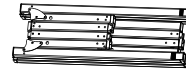

■ Legs (2pcs)



■ Tightening knobs



■ Fabric Package Bag (1pc)



■ White screen(1pc)



■ Gray screen (Optional)



■ Instruction Manual (1pc)

### Accessories List

| Specification(in) |      | 100 | 120、150、180、200 |
|-------------------|------|-----|-----------------|
| Name              | Unit | Qty | Qty             |
| Screw Bar         | Pcs  | 14  | 12              |

Sizes and specifications are subject to change at anytime.

### Frame Specifications

| Model                           | Sizes     | Application   |
|---------------------------------|-----------|---|
| Large-Stage Super Mobile series | 32mmx32mm | Applies up to 200" Large Stage Super Mobile screens |

Sizes and specifications are subject to change at anytime.

## Installation

This projection screen should be installed at the best possible viewing position for the audience. Front projection (Fig. 1) and Rear projection (Fig. 2). Install according to material chosen.

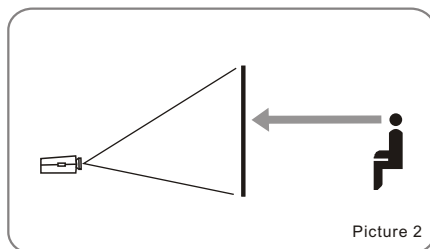
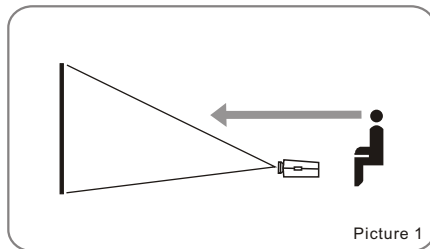

1. Unpack and extend frame on a flat surface (Fig. 3&4).

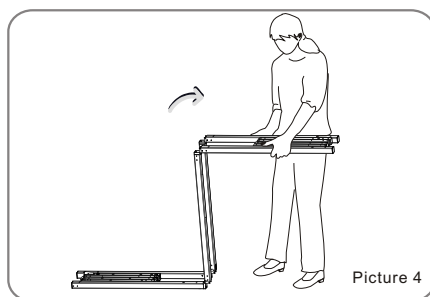
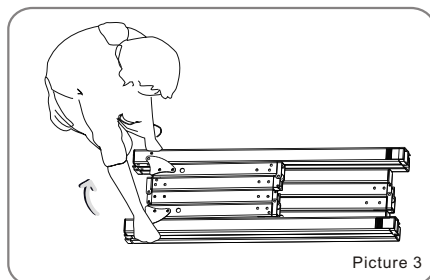

## Disassembly

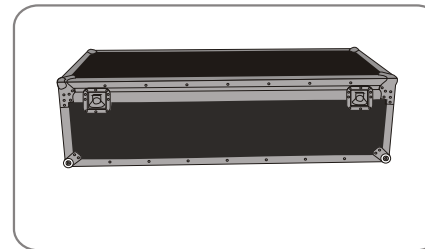

11. To disassemble, reverse steps 1-10.

## Installation

9. It's best to attach legs to frame on flat ground. When raising the screen, ensure double-sided snaps (for masking custom masking-curtain) are on bottom (Fig. 20 & 21).

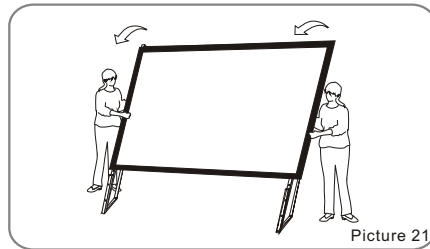
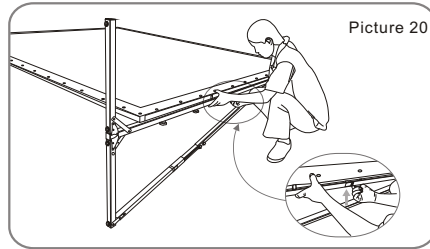

10. Pull down front feet for stability (Fig 22 & 23).

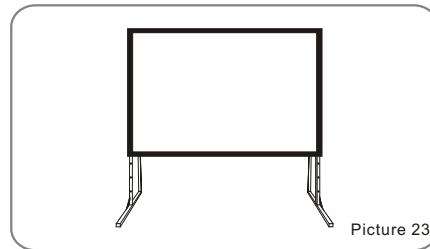
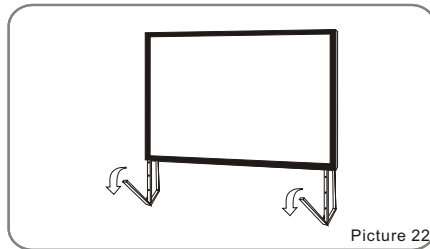

## Installation

2. To secure frame, "click" hinges into place (Fig. 5&6).

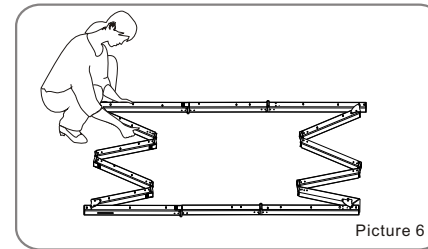
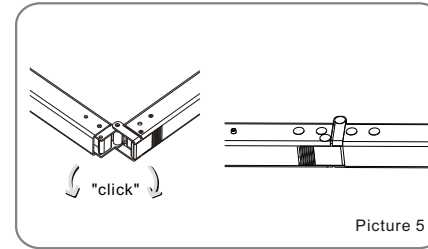

3. Make sure 4 corners are 90 degrees then secure with support beams (Fig. 7-9).

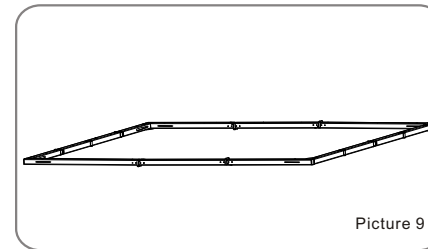
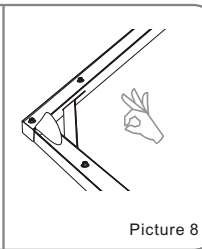
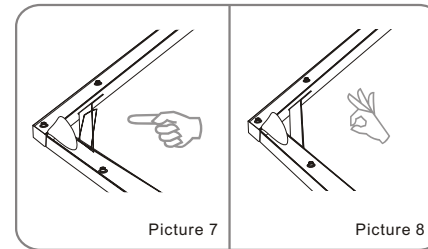

## Installation

4. Unfold screen fabric and lay over frame (Fig. 10-11).

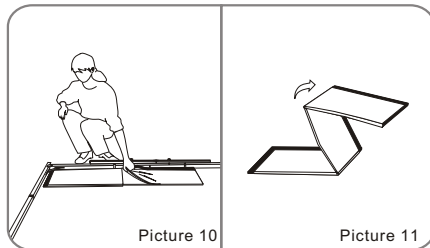

5. Snap screen buttons to frame. Start at top and finish at bottom (Fig. 12-15).

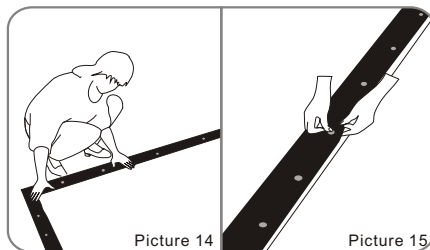
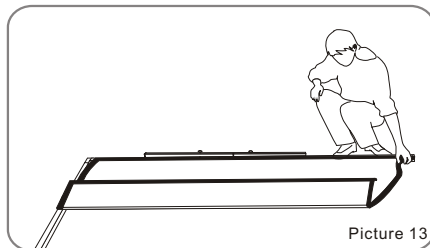
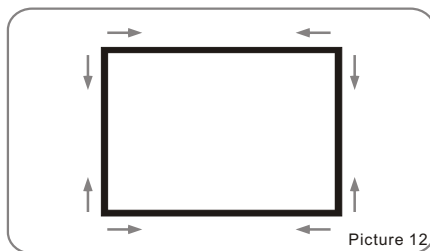

## Installation

7. Unpack and extend legs (Fig. 16).

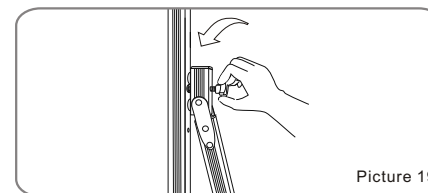
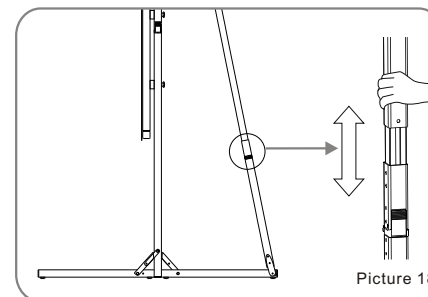
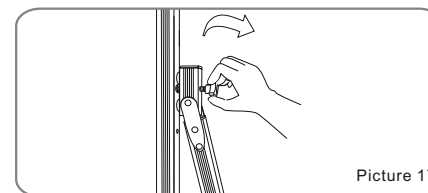
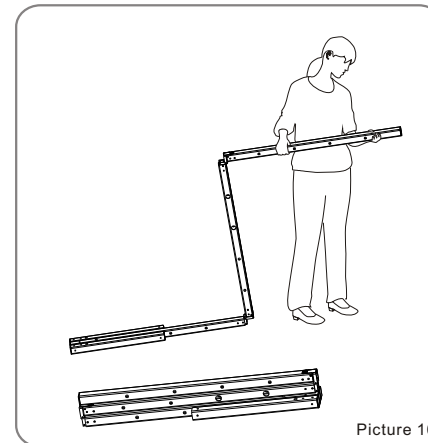

8. Set frame to desired height then extend legs accordingly and fasten with black knob (Fig. 17-19).